

Connections for stage equipment LS-TYPE

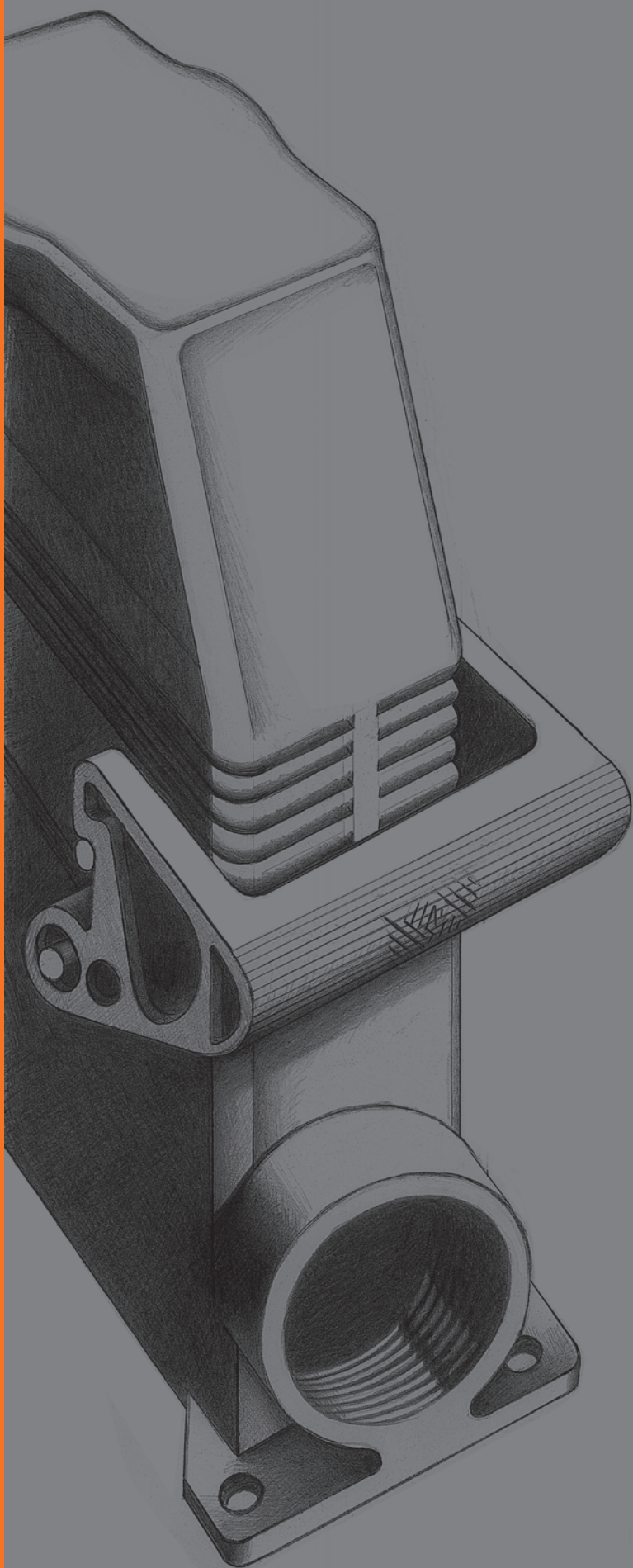

The Company and the Product

I.L.M.E. SpA - INDUSTRIA LOMBARDA MATERIALE ELETTRICO - has been operating in Milan since 1938, in particular in the electrotechnical sector for the manufacturing of equipment for industrial installations.

ILME reflects the traditional **entrepreneurial spirit of Lombardy**, and has enjoyed continuous expansion for over half a century.

The company has carved an important role for itself in the main world markets, also operating directly in the countries that have assumed world leadership in the field of automation, including Germany and Japan.

In the **electrical connection** sector with applications in industrial automation, characterised by **top performance** and utmost **reliability needs**, ILME is today the acknowledged partner of many leading companies worldwide.

The company's fundamental values are:



product innovation, original solutions, excellent **price-quality ratio**, a customer-oriented **sense of service**, ethical behaviour and an environmentally-friendly approach.

To promote the continuing improvement of its **qualitative results**, ILME has always encouraged its collaborators to work with utmost **responsibility and participation**. The company focuses on a series of benefits to the user, including research into the most suitable materials, high quality and safe cabling, a rapid turnaround and readily available services.

CE marking

As from 1 January 1997, in order to launch electrical products on the European market the manufacturer must ensure these bear the relevant CE marking, in line with the Low Voltage Directive 73/23/EEC * (implemented in Italy as law 18-10-1977 no. 791) and its modification 93/68/EEC * (implemented in Italy as L. D. 25-11-1996 no. 626/96, published in the supplement to the Gazzetta Ufficiale of 14-12-1996).

The CE marking must be placed on the product - or, if this is not possible, on the packaging, the instructions for use or the warranty certificate - and acts as a declaration by the manufacturer that the product complies with all relevant EU directives.

ILME products bear the CE marking on the product or packaging.

Almost all ILME products fall within the scope of the Low Voltage Directive. A declaration of compliance is required before applying the CE marking. This document, to which the market is not directly entitled, must be made available to the control authorities (in Italy the Ministry for Industry, Commerce and Handicraft) at all times.

In it, the manufacturer declares the technical safety standard(s) followed to manufacture the product. These standards must be, in decreasing order of preference:

- a European standard (EN prefix)
- a European harmonisation document (HD prefix)
- an international IEC standard
- a national standard
- in the absence of reference standards, the manufacturer's internal specifications, guaranteeing compliance with the directive's basic safety requirements.

Compliance with harmonised technical standards (i.e. ratified by the CENELEC) constitutes presumed conformity to the directive's basic safety requirements.

The CE marking of ILME products results from said products' declaration of conformity to harmonised standards or international IEC standards.

Through the CE marking, ILME declares full compliance, not merely with the directive's basic safety requirements, but also with those

international or national EU standards on which voluntary safety certification markings are based (e.g. IMQ and VDE).

In this way, ILME intends to award the CE marking the value of self-certification in terms of safety, given the loss in legal value of voluntary certifications issued by third parties, ratified by directive 93/68/EEC *.

Notwithstanding the above, practically all ILME products still bear voluntary conformity markings.

The above mentioned EU declaration of conformity becomes null and void when the assembly of products includes one or more components not manufactured by ILME and without CE marking.

* Note:

The next legal reference for the Low Voltage Directive was 2006/95/EC, as consolidation of the original Directive 73/23/EEC + Directive 93/68/EEC.

On 29th March 2014, the Official Journal of the European Union published the new Low Voltage directive 2014/35/EU dd. 26th February 2014, a recast version of directive 2006/95/EC, which is in force since on 20th April 2016.

The new **LS-TYPE** enclosures are the ideal solution for the entertainment industry (lighting system power supply and related mixer and dimmer panels), including theatre stages, film sets, radio and TV studios, discos, trade fair booths, concert halls and night public events, both indoors and outdoors, etc.

All parts are in elegant RAL 9005 black to make them suitable for situations and locations where they should not be visible in the dark.

LS-TYPE connectors



LS-TYPE Plugs & Sockets

The enclosures are available in the standard sizes 44.27, 57.27, 77.27 and 104.27.

They are designed to accommodate all types of connector inserts (crimp, screw, or spring connections as well as the innovative Squich connection).

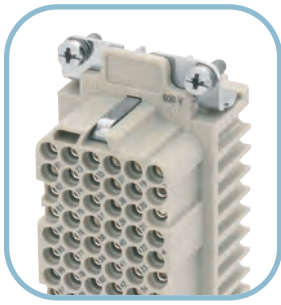

CRIMP

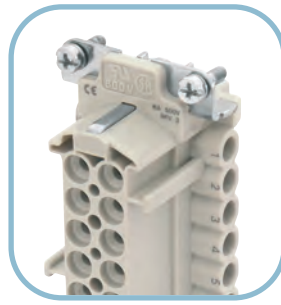

SCREW



SPRING



SQUICH

The metal enclosures maintains the same outstanding characteristics as the grey colour versions.

The overall dimensions and the fastening flanges are unchanged from the corresponding traditional versions. Therefore, the new enclosures can be used as an alternative to the classic version.

The levers are made of thermoplastic material and are easy to replace in case of breakdowns due to severe impacts during the set-up and break down of the stages, lighting systems etc.

EASY LEVER REPLACEMENT



The suffix N identifies the new **LS-TYPE** series:

- CHIN bulkhead mounting housing with lever(s)
- MAPN surface mounting housing high construction with lever(s)
- MFVN hood with pegs top entry high construction
- MFON hood with pegs side entry high construction
- MFVN G hood with lever(s) and gasket top entry, high construction
- CHCN covers with pegs
- CHCN G covers with lever(s) and gasket

The enclosures provide IP65 degree of protection (in accordance with EN 60529) when coupled and locked through the locking levers. The range of operating ambient temperature is $-40^{\circ}\text{C} \div +125^{\circ}\text{C}$.

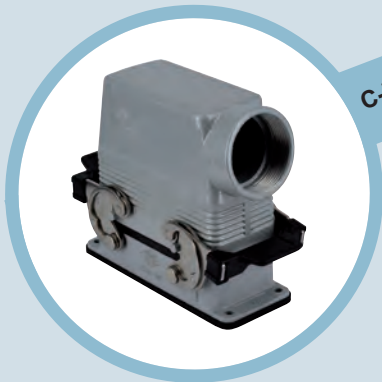

C-TYPE



LS-TYPE

NEW



V-TYPE
IP67



CENTRAL
LEVER

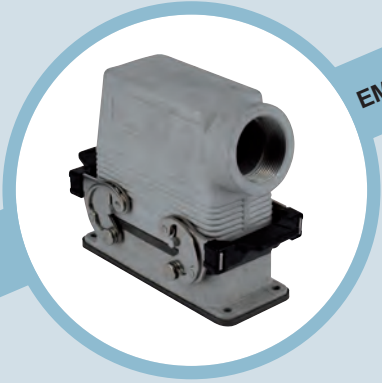

EMC



T-TYPE
Insulating

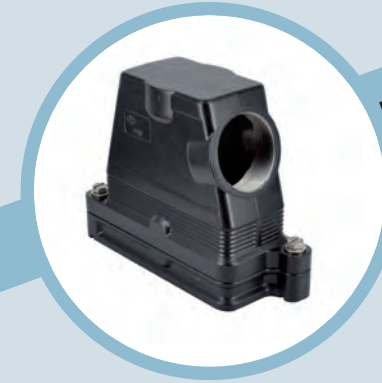

IP68

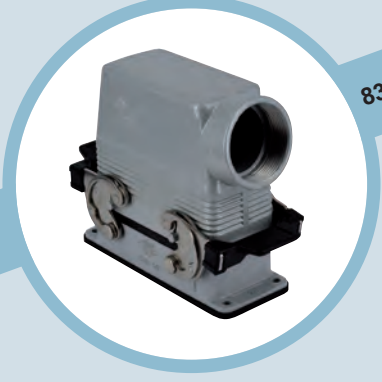

830V



JEI
Economic



W-TYPE



180 °C

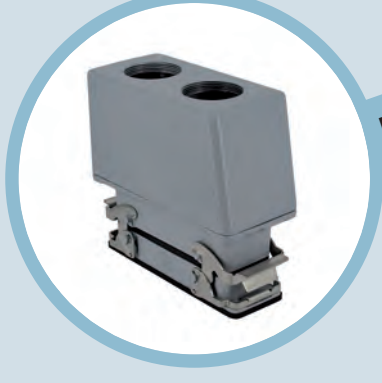

BIG

**SELECT YOUR CONNECTOR
ENTER YOUR APPLICATION...
...FIND OUR PROPOSED SOLUTION**

www.ilme.com



inserts:		page
CDD	24 poles + ⊕	59 *
CQE	10 poles + ⊕	80 *
CSH	6 poles + ⊕	88 *
CCE	6 poles + ⊕	94 *
CNE, CSE, JCNE, JCSE	6 poles + ⊕ 95 and 106*	
CSS	6 poles + ⊕	118 *
CTE, CTSE (**)	6 poles + ⊕	126 *
MIXO	2 modules	160+195 *

**) only in the CHIN 06 L enclosure

insert centre distance: 44 x 27 mm

* refer to catalogue page CN.12

housings with single lever



hoods with 2 pegs



description	part No.	entry M	part No.	entry M
bulkhead mounting housing, with lever	CHIN 06 L			
surface mounting housing, high construction, with lever	MAPN 06 L32	32		
with pegs, side entry			MHON 06 L25	25
with pegs, side entry, high construction			MFON 06 L25	25
with pegs, top entry			MHVN 06 L25	25
with pegs, top entry, high construction			MFVN 06 L25	25

panel cut-out for bulkhead mounting housing in mm

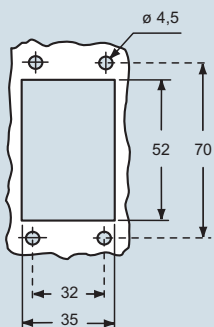

dimensions in mm

CHIN 06 L

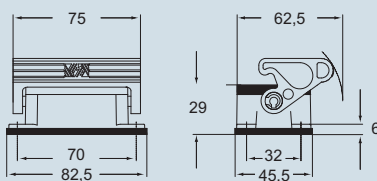

MAPN 06 L32

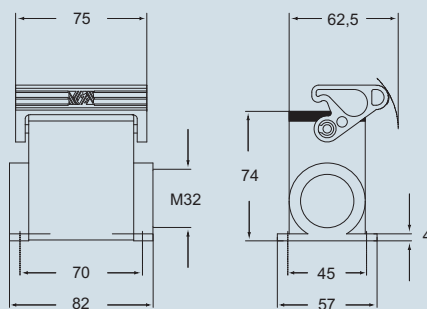

- kiln powder coating with RAL 9005 black epoxy polyester powder
- RAL 9005 black self-extinguishing thermoplastic locking lever (spare lever page 12)

dimensions in mm

MFON 06 L25

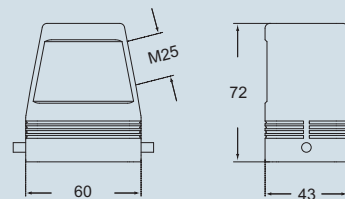

MFVN 06 L25

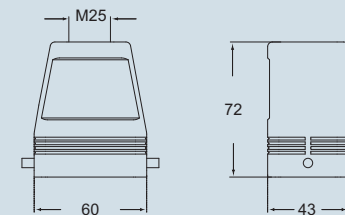

MHON 06 L25

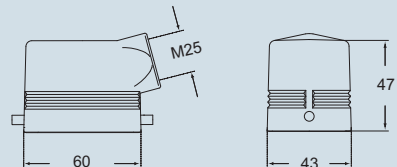

MHVN 06 L25

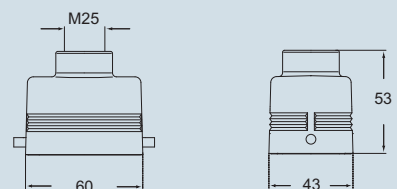

dimensions shown are not binding and may be changed without notice



inserts:		page
CDD	24 poles + ⊕	59 *
CQE	10 poles + ⊕	80 *
CSH	6 poles + ⊕	88 *
CCE	6 poles + ⊕	94 *
CNE, CSE, JCNE, JCSE	6 poles + ⊕	95 and 106 *
CSS	6 poles + ⊕	118 *
MIXO	2 modules	160+195 *

insert centre distance: 44 x 27 mm

* refer to catalogue page CN.12

hoods with 2 pegs



covers



description	part No.	entry M	part No.
with lever and gasket, top entry	MHVN 06 LG25	25	
with lever and gasket, top entry, high construction	MFVN 06 LG25	25	

covers with pegs covers with lever		CHCN 06 L CHCN 06 LG
---------------------------------------	--	-------------------------

- kiln powder coating with RAL 9005 black epoxy polyester powder
- RAL 9005 black self-extinguishing thermoplastic locking lever (spare lever page 12)

dimensions in mm

MHVN 06 LG25

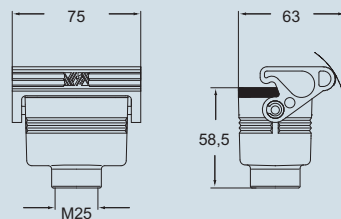

MFVN 06 LG25

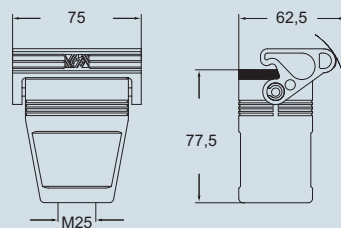

dimensions in mm

CHCN 06 L

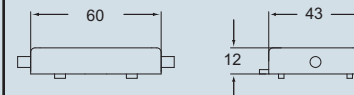

CHCN 06 LG

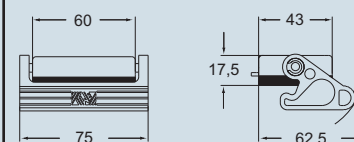

dimensions shown are not binding and may be changed without notice



inserts:		page
CDD	42 poles + ⊕	61 *
CQE	18 poles + ⊕	81 *
CSH	10 poles + ⊕	89 *
CCE	10 poles + ⊕	90 *
CNE, CSE, JCNE, JCSE	10 poles + ⊕ 97 and 107 *	
CSS	10 poles + ⊕	119 *
CTE, CTSE **)	10 poles + ⊕	127 *
CMSE	3+2 (aux) poles + ⊕	135 *
CMCE	3+2 (aux) poles + ⊕	134 *
CX	8/24 poles + ⊕	151 *
MIXO	3 modules	160+195 *

**) only in the CHIN 10 enclosure

insert centre distance: 57 x 27 mm

* refer to catalogue page CN.12

housings with double lever



hoods with 4 pegs



description	part No.	entry M	part No.	entry M
bulkhead mounting housing, with 2 levers	CHIN 10			
surface mounting housing, high construction, with 2 levers	MAPN 10.32	32		
with pegs, side entry			MHON 10.25	25
with pegs, side entry, high construction			MFON 10.32	32
with pegs, top entry			MHVN 10.25	25
with pegs, top entry, high construction			MFVN 10.32	32

panel cut-out for bulkhead mounting housing in mm

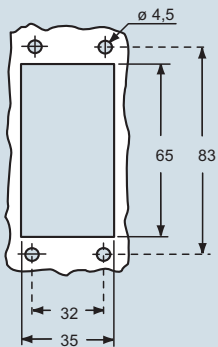

dimensions in mm

CHIN 10

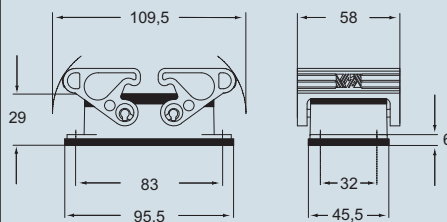

MAPN 10.32

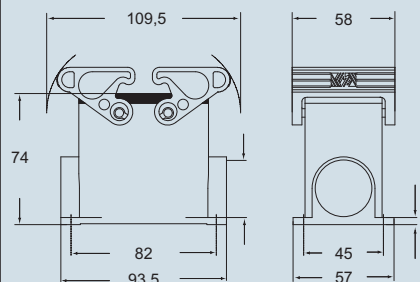

dimensions in mm

MFON 10.32

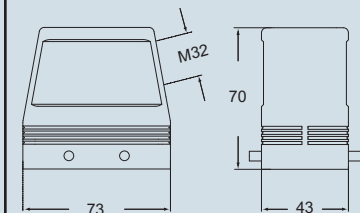

MFVN 10.32

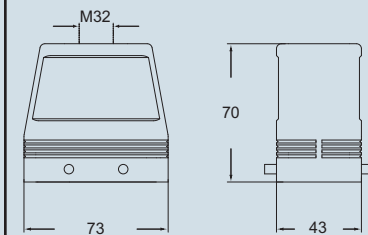

MHON 10.25

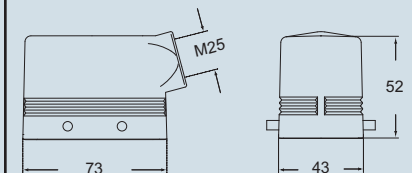

MHVN 10.25

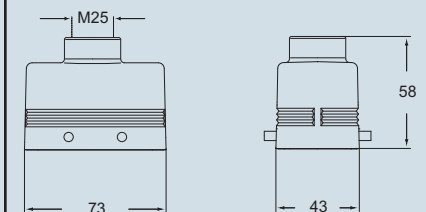

- kiln powder coating with RAL 9005 black epoxy polyester powder
- RAL 9005 black self-extinguishing thermoplastic locking lever (spare lever page 12)



dimensions shown are not binding and may be changed without notice



inserts:		page
CDD	42 poles + ⊕	61 *
CQE	18 poles + ⊕	81 *
CSH	10 poles + ⊕	89 *
CCE	10 poles + ⊕	90 *
CNE, CSE, JCNE, JCSE	10 poles + ⊕ 97 and 107 *	
CSS	10 poles + ⊕	119 *
CMSE	3+2 (aux) poles + ⊕	135 *
CMCE	3+2 (aux) poles + ⊕	134 *
CX	8/24 poles + ⊕	151 *
MIXO	3 modules	160+195 *

insert centre distance: 57 x 27 mm

* refer to catalogue page CN.12

hoods with 4 pegs



covers



description	part No.	entry M
with 2 levers and gasket, top entry	MHVN 10 G25	25
with 2 levers and gasket, top entry, high construction	MFVN 10 G32	32

part No.	entry M
MHVN 10 G25	25
MFVN 10 G32	32

part No.
CHCN 10
CHCN 10 G

covers with pegs
covers with 2 levers

- kiln powder coating with RAL 9005 black epoxy polyester powder
- RAL 9005 black self-extinguishing thermoplastic locking lever (spare lever page 12)

dimensions in mm

MHVN 10 G25

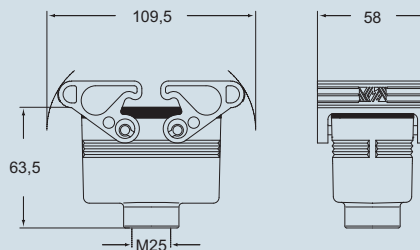

MFVN 10 G32

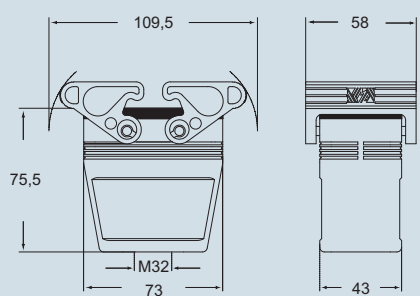

dimensions in mm

CHCN 10

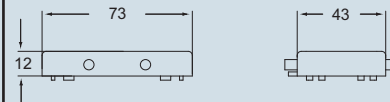

CHCN 10 G

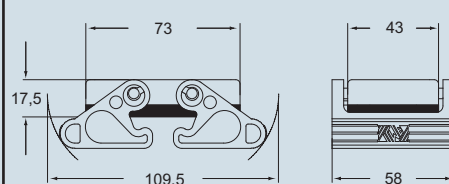

dimensions shown are not binding and may be changed without notice



inserts:	page
CD	40 poles + ⊕ 49+52 *
CT, CTS **).....	40 poles + ⊕ 56 *
CDD	72 poles + ⊕ 62+65 *
CQE	32 poles + ⊕ 82+84 *
CSH	16 poles + ⊕ 90+92 *
CCE	16 poles + ⊕ 98+102 *
CNE, CSE, JCNE, JCSE	16 poles + ⊕ 99 and 108 *
CSS	16 poles + ⊕ 120+122 *
CTE, CTSE **).....	16 poles + ⊕ 128 *
CMSE	6+2 (aux) poles + ⊕ 137 *
CMCE	6+2 (aux) poles + ⊕ 136 *
CP	6 poles + ⊕ 149+150 *
CX	6/36 e 12/2 poles + ⊕ 152+153 *
CX	4/0 e 4/2 poles + ⊕ 154 *
MIXO	4 modules 160+195 *

**) only in the CHIN 16 enclosure

insert centre distance: 77,5 x 27 mm

* refer to catalogue page CN.12

housings with double lever



hoods with 4 pegs



description	part No.	entry M	part No.	entry M
bulkhead mounting housing, with 2 levers	CHIN 16			
surface mounting housing, high construction, with 2 levers	MAPN 16.32	32		
with pegs, side entry			MHON 16.32	32
with pegs, side entry, high construction			MFON 16.32	32
with pegs, top entry			MHVN 16.32	32
with pegs, top entry, high construction			MFVN 16.32	32

panel cut-out for bulkhead mounting housing in mm

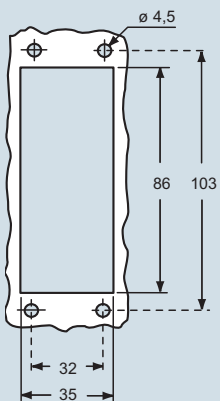

- kiln powder coating with RAL 9005 black epoxy polyester powder
- RAL 9005 black self-extinguishing thermoplastic locking lever (spare lever page 12)

dimensions in mm

CHIN 16

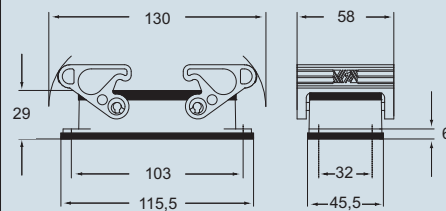

MAPN 16.32

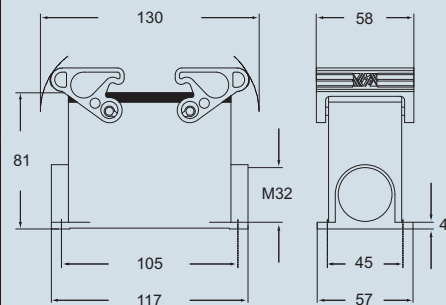

dimensions in mm

MFON 16.32

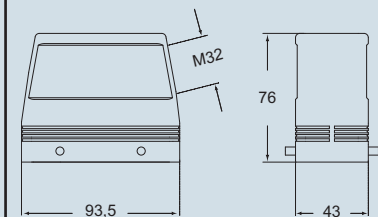

MFVN 16.32

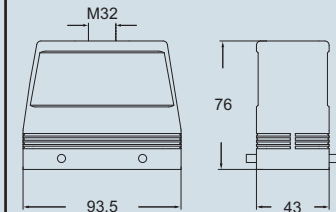

MHON 16.32

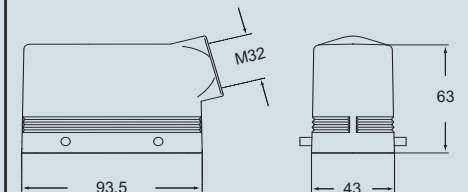

MHVN 16.32

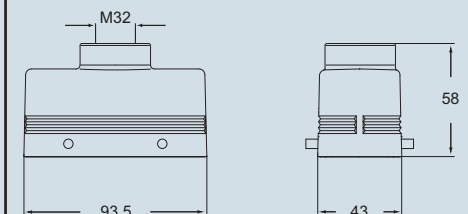

dimensions shown are not binding and may be changed without notice



inserts:	page
CD	40 poles + ⊕ 49+52 *
CDD	72 poles + ⊕ 62+65 *
CQE	32 poles + ⊕ 82+84 *
CSH	16 poles + ⊕ 90+92 *
CCE	16 poles + ⊕ 98+102 *
CNE, CSE, JCNE, JCSE	16 poles + ⊕ 99 and 108 *
CSS	16 poles + ⊕ 120+122 *
CMSE	6+2 (aux) poles + ⊕ 137 *
CMCE	6+2 (aux) poles + ⊕ 136 *
CP	6 poles + ⊕ 149+150 *
CX	6/36 e 12/2 poles + ⊕ 152+153 *
CX	4/0 e 4/2 poles + ⊕ 154 *
MIXO	4 modules 160+195 *

insert centre distance: 77,5 x 27 mm

* refer to catalogue page CN.12

hoods with 4 pegs



covers



description	part No.	entry M	part No.
with 2 levers and gasket, top entry	MHVN 16 G32	32	
with 2 levers and gasket, top entry, high construction	MFVN 16 G32	32	

cover with pegs cover with 2 levers	dimensions in mm	dimensions in mm
	MHVN 16 G32	CHCN 16 CHCN 16 G

- kiln powder coating with RAL 9005 black epoxy polyester powder
- RAL 9005 black self-extinguishing thermoplastic locking lever (spare lever page 12)

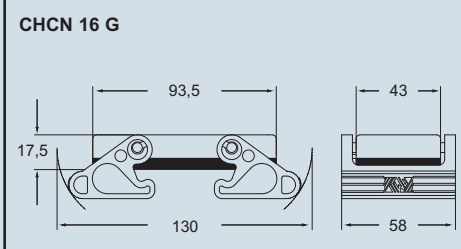
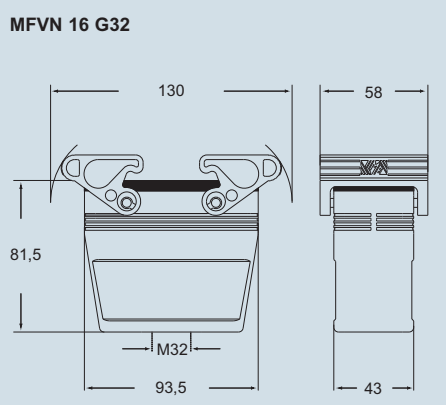
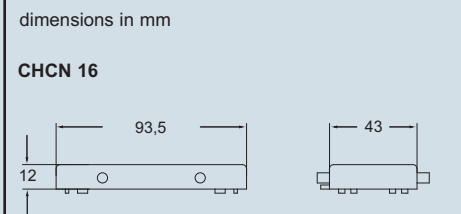
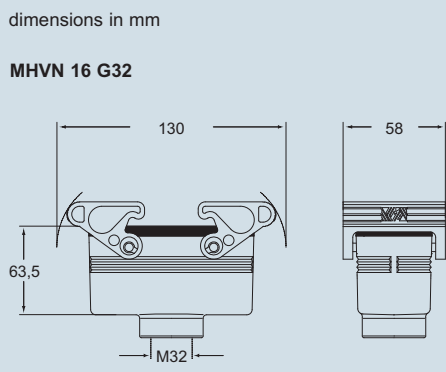

dimensions shown are not binding and may be changed without notice



inserts:		page
CD	64 poles + ⊕	51+53 *
CT, CTS **).....	64 poles + ⊕	57 *
CDD	108 poles + ⊕	64+66 *
CQE	46 poles + ⊕	83+85 *
CSH	24 poles + ⊕	91+93 *
CCE	24 poles + ⊕	100+104 *
CNE, CSE, JCNE, JCSE	24 poles + ⊕	101 and 109 *
CSS	24 poles + ⊕	122+123 *
CTE, CTSE **).....	24 poles + ⊕	129 *
CMSE	10+2 (aux) poles + ⊕	139 *
CMCE	10+2 (aux) poles + ⊕	138 *
CX	4/8 poles + ⊕	155 *
MIXO	6 modules	160+195 *

**) only in the CHIN 24 enclosure

insert centre distance: 104 x 27 mm

* refer to catalogue page CN.12

housings with double lever



hoods with 4 pegs



description	part No.	entry M	part No.	entry M
bulkhead mounting housing, with 2 levers	CHIN 24			
surface mounting housing, high construction, with 2 levers	MAPN 24.32	32		
with pegs, side entry			MHON 24.32	32
with pegs, side entry, high construction			MFON 24.32	32
with pegs, side entry			MHVN 24.32	32
with pegs, side entry, high construction			MFVN 24.32	32

panel cut-out for bulkhead mounting housing in mm

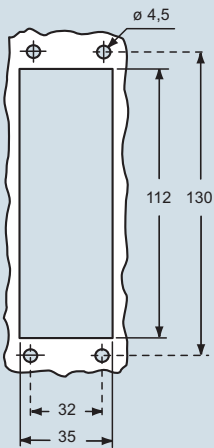

- kiln powder coating with RAL 9005 black epoxy polyester powder
- RAL 9005 black self-extinguishing thermoplastic locking lever (spare lever page 12)

dimensions in mm

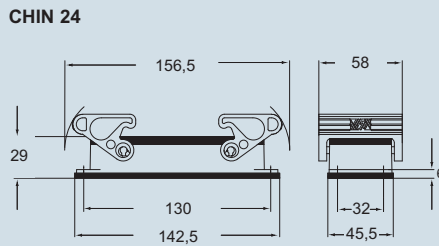

MAPN 24.32

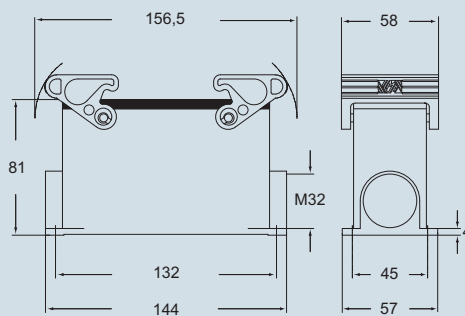

dimensions in mm

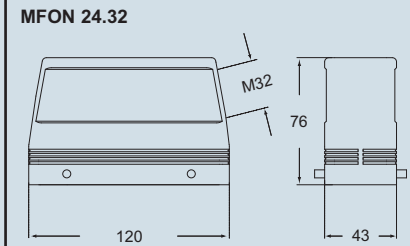

MFVN 24.32

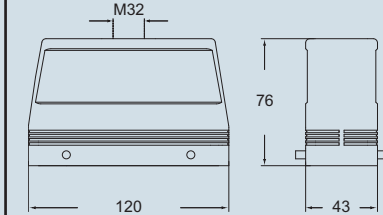

MHON 24.32

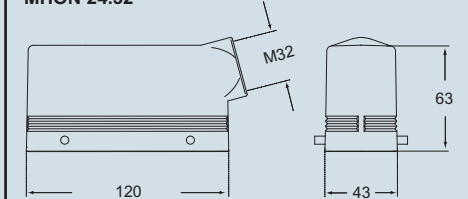

MHVN 24.32

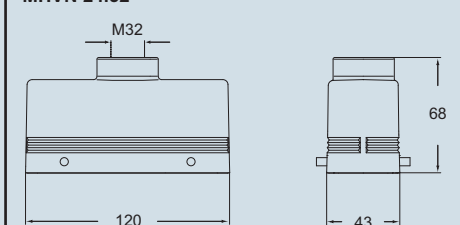

dimensions shown are not binding and may be changed without notice



inserts:	page
CD 64 poles + ⊕	51+53 *
CDD 108 poles + ⊕	64+66 *
CQE 46 poles + ⊕	83+85 *
CSH 24 poles + ⊕	91+93 *
CCE 24 poles + ⊕	100+104 *
CNE, CSE, JCNE, JCSE	24 poles + ⊕ 101 and 109 *
CSS 24 poles + ⊕	121+123 *
CMSE 10+2 (aux) poles + ⊕	139 *
CMCE 10+2 (aux) poles + ⊕	138 *
CX 4/8 poles + ⊕	155 *
MIXO 6 modules	160+195 *

insert centre distance: 104 x 27 mm

* refer to catalogue page CN.12

hoods with 4 pegs



covers



description	part No.	entry M	part No.
with 2 levers and gasket, top entry	MHVN 24 G32	32	CHCN 24 CHCN 24 G
with 2 levers and gasket, top entry, high construction	MFVN 24 G32	32	

covers with pegs
covers with 2 levers

dimensions in mm

MHVN 24 G32

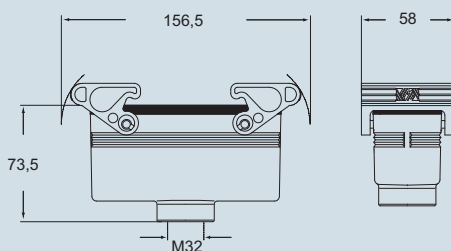

MFVN 24 G32

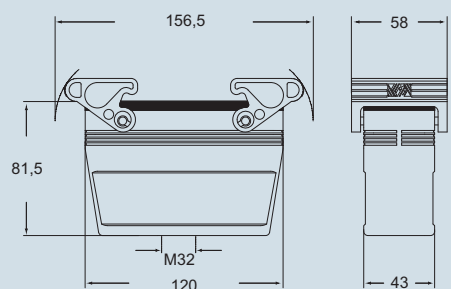

dimensions in mm

CHCN 24

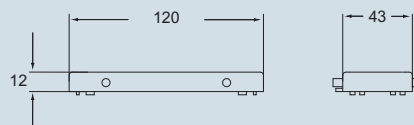

CHCN 24 G

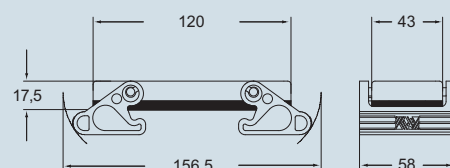

- kiln powder coating with RAL 9005 black epoxy polyester powder
- RAL 9005 black self-extinguishing thermoplastic locking lever (spare lever page 12)



dimensions shown are not binding and may be changed without notice

spare part lever



spare part lever



description

part No.

part No.

for "44.27" enclosures with levers

CR 06 LN

for "57.27", "77.27", "104.27" enclosures with levers

CR LN

dimensions in mm

CR 06 LN

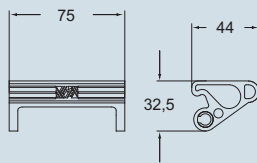

dimensions in mm

CR LN

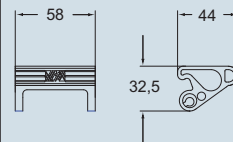

dimensions shown are not binding and may be changed without notice

CK - CKS
 Screw terminal connection 10A - 250V
 Spring connection 10A - 400V
 from page 40



CD
 Crimp connection 10A - 250V
 10A - 50V
 from page 44

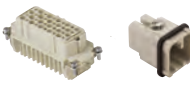

CT - CTS
 Screw terminal connection 10A - 250V
 Spring connection 10A - 250V
 from page 54



CDD
 Crimp connection 10A - 250V
 from page 58



CQ
 Crimp connection 10A/16A/40A
 from page 67



CDA - CDC
 Screw terminal connection 16A - 250V
 Crimp connection 16A - 250V
 from page 72



CQE
 Crimp connection 16A - 500V
 from page 79



CSH
 Spring connection without tools 16A - 500V
 from page 86



CNE - CSE - CCE
 Screw terminal connection 16A - 500V
 Spring connection 16A - 500V
 Crimp connection 16A - 500V
 from page 94



JCNE - JCSE
 Screw terminal connection 16A - 500V
 Spring connection 16A - 500V
 from page 106



CSS
 Spring connection dual terminal 16A - 500V
 from page 118



CT - CTE - CTS
 Screw terminal connection 16A - 400V/500V
 Spring connection
 from page 124



C-TYPE page 200
 - metallic
 - CLASS rotative lever
 - IP65/IP66



V-TYPE IP67 page 249
 - metallic
 - water tightness in a limited space
 - lever in stainless steel
 - IP66/IP67



V-TYPE IP65/IP66 page 260
 - metallic
 - water tightness in a limited space
 - lever in stainless steel
 - IP65/IP66



T-TYPE page 277
 - insulating
 - robust
 - resistant to chemical agents
 - IP65



JEI page 287
 - metallic
 - lever in galvanised steel
 - economic
 - IP65/IP66



BIG - HOOD page 296
 - large and modular
 - multiple cable entries
 - simple and easy cable inspection
 - seat for electronic boards
 - IP66



CMCE - CME - CMSE

Crimp connection 16A - 830V
Screw terminal connection 16A - 830V
Spring connection 16A - 830V
..... from page 134



CP

Screw terminal connection 35A - 400/690V
..... from page 149



CX - MIXED INSERTS

Crimp connection 10A/16A/40A
..... from page 151



CX

Screw terminal connection 16A/80A
..... from page 154



MIXO

Crimp connection 200A/100A/70A
40A/16A/10A/5A
..... from page 160



MIXO

Screw terminal connection 40A
..... from page 165

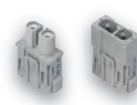

MIXO

Spring connection 16A
..... from page 172



MIXO

Data RJ45-USB-POF
BUS-COAX
..... from page 183



MIXO

Pneumatic
..... from page 191

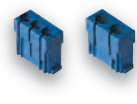

DESINA

Crimp connection
..... from page 449



COB

- mounting inside control panel
- inspectable
..... page 408



PANEL MOUNTING

..... page 427



W-TYPE

page 322
- metallic with chrome treatment
- for aggressive environments
- IP66



EMC

page 335
- for electromagnetic compatibility
- with conductive gaskets
- IP66



180 °C

page 352
- metallic
- for high temperature environments
- IP65



CENTRAL LEVER

page 359
- for limited mounting spaces
- reduces insert uncoupling stress
- IP65



IP68

page 369
- watertight
- mechanical robustness
- resistant to chemical agents
- screw or bayonet locking



830V

page 391
- insulated for CME
and CMCE 16p inserts
- CLASS rotative lever
- IP65/IP66



inserts:		page
CK	3 poles + ⊕	40 *
CK	4 poles + ⊕	40 *
CKS	3 poles + ⊕	41 *
CKS	4 poles + ⊕	41 *
CD	7 poles + ⊕	45 *
CD	8 poles	46 *
CQ	5 poles + ⊕	69 *
CQ	12 poles + ⊕	68 *

insert dimensions:
21 x 21 mm

* page references CN.12 catalogue

bulkhead mounting housings



angled bulkhead mounting housings



description	part no.	part no. (entry - Pg 11)	part no. (entry - M 20)
with lever	CK 03 IN (black)		
without cable gland entry, with lever		CK 03 IAN (black)	
with cable gland entry and lever		CK 03 IAPNS (black)	MK IAPN20 (black)
gasket and screw kit for IP66/IP67 ¹⁾ for CK, CQ 05, CKS inserts	CKR 65	CKR 65	
gasket and screw kit for IP66/IP67 ¹⁾ for CD 07/08 inserts	CKR 65 D	CKR 65 D	

1) To obtain the protection rating IP66/IP67 a kit is provided that includes a gasket to fit under the insert fixing screws supplied with the kit (see illustrative example)
CQ 12 inserts are already supplied with a gasket and screw which ensure IP66/IP67 protection rating

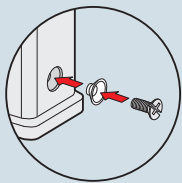

panel cut-out for enclosures, in mm

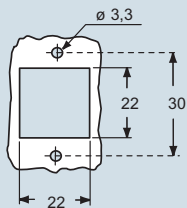

dimensions in mm

CK IN

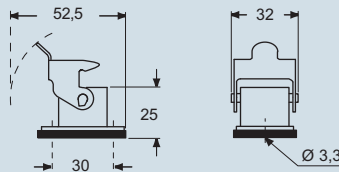

dimensions in mm

CK IAN

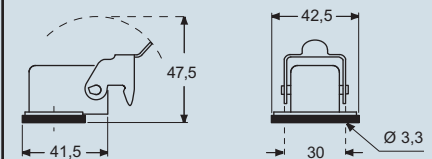

CK IAPNS and MK IAPN

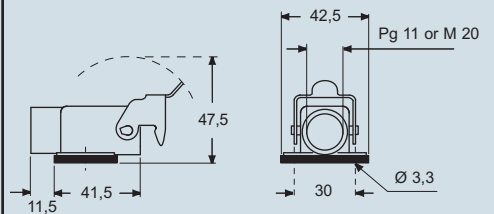

CRUS® Type 12
Type 4/4X only
with CKR 65 (D)



IP66/IP67 with CKR 65 (D) ¹⁾

dimensions shown are not binding
and may be changed without notice

inserts:		page
CK	3 poles + ⊕	40 *
CK	4 poles + ⊕	40 *
CKS	3 poles + ⊕	41 *
CKS	4 poles + ⊕	41 *
CD	7 poles + ⊕	45 *
CD	8 poles	46 *
CQ	5 poles + ⊕	69 *
CQ	12 poles + ⊕	68 *

insert dimensions:
21 x 21 mm

* page references CN.12 catalogue

hoods



covers



description	part no. (entry - Pg 11)	part no. (entry - M 20)	part no.
with pegs, top entry	CK 03 VNS (black)	MK VN20 (black)	
with pegs, top entry	CK 03 VANS (black)	MK VAN20 (black)	
with lever, top entry	CK 03 VGNS (black)	MK VGN20 (black)	
with pegs and gasket, for female inserts with pegs, for male inserts			CK 03 CN (black) CK 03 CAN (black)
with lever and gasket, for female inserts with lever, for male inserts			CK 03 CXN (black) CK 03 CXAN (black)
gasket and screw kit for IP66/IP67 ¹⁾ for CK, CQ 05, CKS inserts	CKR 65		
gasket and screw kit for IP66/IP67 ¹⁾ for CD 07/08 inserts	CKR 65 D		

1) To obtain the protection rating IP66/IP67 a kit is provided that includes a gasket to fit under the insert fixing screws supplied with the kit (see illustrative example)
CQ 12 inserts are already supplied with a gasket and screw which ensure IP66/IP67 protection rating

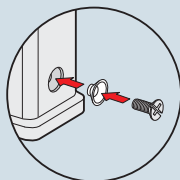

dimensions in mm

CK VNS and MK VN

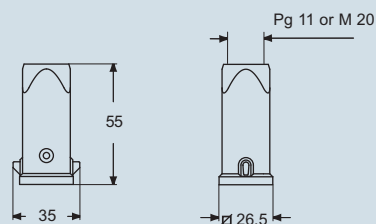

CK VANS and MK VAN

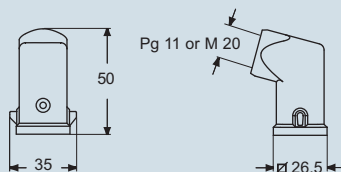

CK VGNS and MK VGN

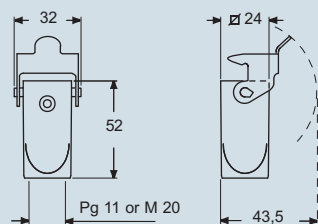

dimensions in mm

CK CN

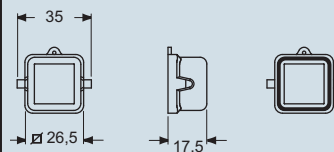

CK CAN

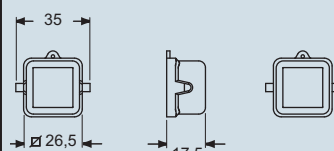

CK CXN

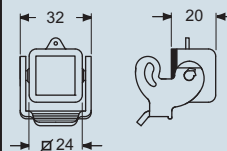

CK CXAN

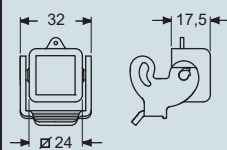

CRUS® Type 12
Type 4/4X only
with CKR 65 (D)



IP66/IP67 with CKR 65 (D) ¹⁾

dimensions shown are not binding
and may be changed without notice

pluso-N - Plugs and sockets for LS-TYPE version

pluso

These products are the ideal choice for the entertainment industry (to supply lighting equipment and mixer/dimmer assemblies) and are typically used on theatre stages, cinema sets, radio and television broadcasting studios, discos, fair stands, concert halls, public night events, both indoors and outdoors, and similar scenarios.

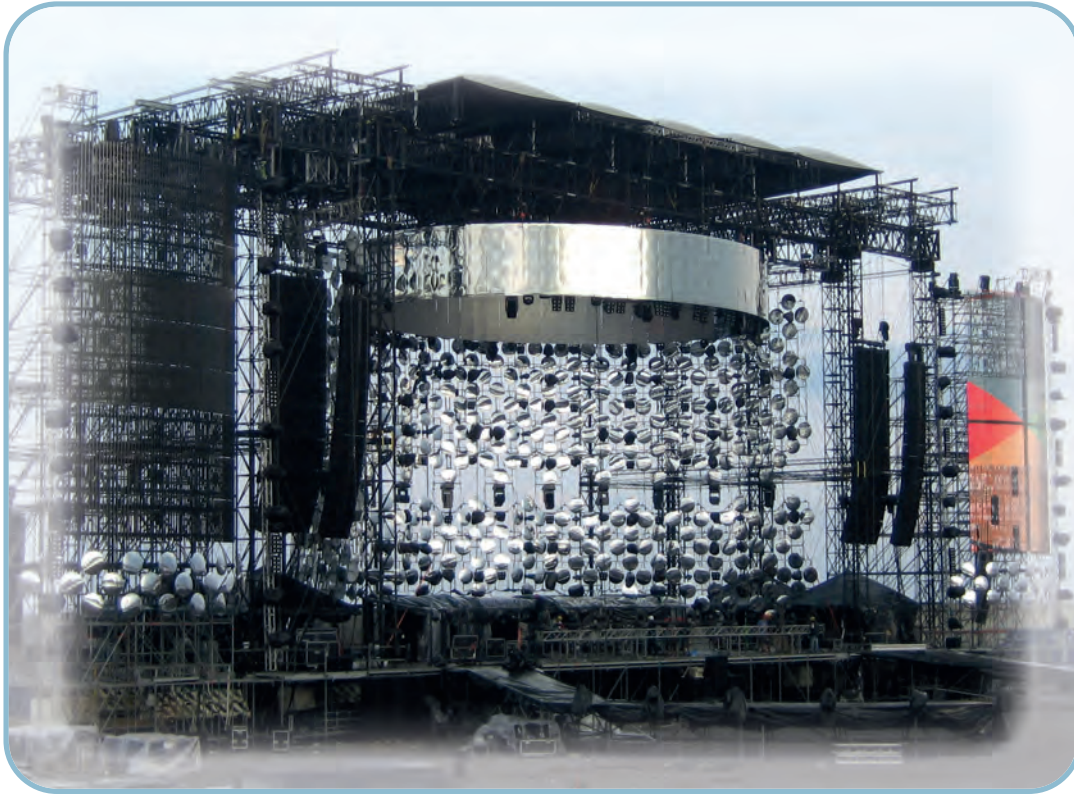

pluso-N - Plugs and sockets for LS-TYPE version

pluso

All models share the extraordinary features of the equivalent versions in grey colour.

The elegant colour of all visible plastic parts and the labels in non reflecting grey, which are used only when the markings are not printed, add a touch of discretion and make these products particularly suitable for scenarios and areas where plugs, sockets and cables should be invisible in absence of light.

The range includes several models:

Couplers, flush-mounting, with IP44 protection degree or IP67 on request (couplers and sockets have an IP66/IP67 protection degree).

NOTE - Products are available with different voltage and/or frequency and current ratings on request.



PN...SV coupler plugs - PN...PV coupler socket-outlets LS-TYPE



- PN...SV types 16A (IP44), entry with cable gland colour RAL 9005 black, enclosure colour RAL 9005 black
- PN...PV types 16A (IP44), enclosure and spring lid colour RAL 9005 black, entry with cable gland
- Compliant with EN 60309-1 and -2
- PN...SV types, enclosure and insert in insulating, thermoplastic, self-extinguishing material
- PN...PV types, enclosure, insert and spring lid in insulating, thermoplastic, self-extinguishing material
- Terminals with retained screws
- IP44 degree of protection (EN 60529)

16A coupler plugs
IP44 degree of protection
low voltage:
from over 50V up to 690V



NEW

16A coupler socket-outlets
IP44 degree of protection
low voltage:
from over 50V up to 690V



NEW

Number of poles	Frequency Hz	Voltage V	Earthing contact position h	Part No.	Part No.
2P+⊕	50 and 60	200 ÷ 250	6	PN 1663 SV	PN 1663 PV
3P+⊕	50 and 60	380 ÷ 415	6	PN 1664 SV	PN 1664 PV
3P+N+⊕	50 and 60	200/346 ÷ 240/415	6	PN 1665 SV	PN 1665 PV

dimensions in mm

(16A) PN ... SV

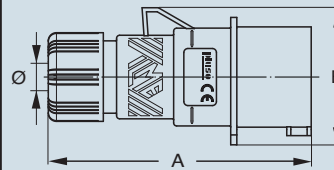

PN...SV	A	B	ø min	ø max
16A 2P+⊕	129	59.5	7	16
3P+⊕	129	67	7	16
3P+N+⊕	129	75	8	24

dimensions in mm

(16A) PN ... PV

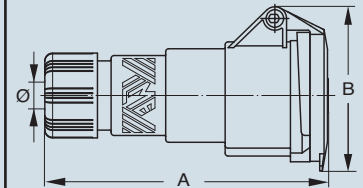

PN...PV	A	B	ø min	ø max
16A 2P+⊕	146	74.5	7	16
3P+⊕	146	84.5	7	16
3P+N+⊕	146	92.5	8	24

dimensions shown are not binding
 and may be changed without notice

- Enclosure and spring lid colour RAL 9005 black
- Compliant with EN 60309-1 and -2
- Enclosure, insert and spring lid in insulating, thermoplastic, self-extinguishing material
- Flange with anti-ageing gasket
- PN...PI - PN...PQ types (IP44), spring lid
- Terminals with retained screws
- IP44 degree of protection (EN 60529)

16A flush-mounting inclined socket-outlets
IP44 degree of protection
low voltage:
from over 50V up to 690V



NEW

16A flush-mounting straight socket-outlets
IP44 degree of protection
low voltage:
from over 50V up to 690V



NEW

Number of poles	Frequency Hz	Voltage V	Earthing contact position h	Part No.	Part No.
2P+⊕	50 and 60	200 ÷ 250	6	PN 1663 PI	PN 1663 PQ
3P+⊕	50 and 60	380 ÷ 415	6	PN 1664 PI	PN 1664 PQ
3P+N+⊕	50 and 60	200/346 ÷ 240/415	6	PN 1665 PI	PN 1665 PQ

dimensions in mm

(16A) PN ... PI

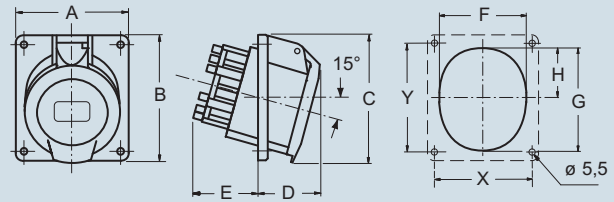

PN ... PI	A	B	C	D	E	F	G	H	X	Y
16A 2P+⊕	64	82	82	38	46	52	62	30	52	60
3P+⊕	64	82	82	42	47	57	65	28	52	60
3P+N+⊕	92	100	100	43	47	66	78	37.5	77	85

(16A) PN ... PQ

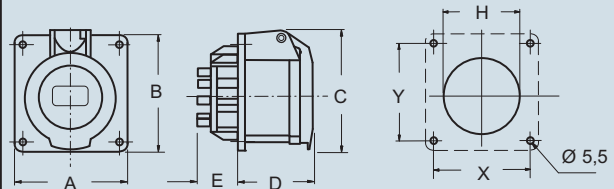

PN...PQ	A	B	C	D	E	H	X	Y
16A 2P+⊕	65	65	71	52	27	60	52	52
3P+⊕	65	65	75	53	27	61.5	52	52
3P+N+⊕	80	80	86	53	27	70	60	60

dimensions shown are not binding
 and may be changed without notice

